

User Manual

For Windows and Macintosh OS

GT-191/GT-220 V2
Graphics IPS Pen Display



Precautions

1. Please read this manual carefully before using, and keep it well for future reference.
2. Before cleaning the display please unplug the USB cable and wipe with a soft damp cloth, do not use any kind of detergents.
3. Please don't place the display near water sources such as bathtub, washbasin, sinks, washing machine, damp basement, swimming pool, etc.
4. Do not place the display on where is unstable or a height for children reaching easily in order to avoid danger.
5. Do not place the display and digital pen close to the magnetic field.
6. The grooves and holes on the back case is designed for ventilation to prevent the monitor from overheating. Please don't place the display on beds, sofas, carpets or in embedded device.
7. Only power supplies shown on the nameplate can be used for the display. If you have questions about the power supply which you are using, please consult the distributor of your display.
8. To protect your display, please switch off the power when it is not in use. During blackouts or not using for long time, please unplug the display from the socket.
9. Don't overload the socket or lengthen the power wire, which may lead to electric shocks.
10. Make sure no foreign bodies get inside the monitor through grooves and prevent liquid from splashing on the display as to prevent short-circuit or fire.
11. If the display has a breakdown, do not open the main case and try to repair it by yourself. Please ask for a service for proper repair and maintenance.
12. When the following situations occur, please unplug the power adapter and you may need a service for full repair and maintenance:
 - A. The power wire or plug is damaged or worn out;
 - B. There is liquid splashed inside of the display;
 - C. The display has fallen or the LCD is broken;
 - D. When obvious abnormalities occur to the display.
13. While getting the components replaced, you are supposed to guarantee that the repairman is using the substitute components specified by the manufacturer. Unauthorized component replacement might cause fire, electric shocks or other dangers.
14. Digital pen has a lithium battery, which should be charged in time under low battery mode, and at the same time should be charged every 3 months; otherwise it will cause lithium battery damage.
15. The nib of the digital pen can't be pressed when it is placing, otherwise the pen can't enter the power-saving state, which is easy to cause lithium battery over-discharge damage.

Contents

1. Product Overview.....	3
1.1 Display Introduction.....	3
1.2 Product and Accessories	3
1.3 Setting up Display.....	5
1.4 Installing the Driver	6
1.5 Pen Nib Replacement.....	7
1.6 Charging the Pen.....	7
2. Product Basic Operation	8
2.1 Using The Pen.....	8
2.2 OSD Setting	10
3. Function Setting	14
3.1 Device Connection Prompt	14
3.2 Working Area Setting	14
3.3 Pen Button Function Setting.....	16
3.4 Pressure Sensitivity Setting.....	16
3.5 Pen Pressure Testing	17
3.6 Calibration	17
3.7 Enable the Windows Ink feature	18
3.8 Data Export and Import	18
4. Specifications	19
5. Trouble Shooting	20
5.1 Possible Breakdowns Related to DISPLAY.....	20
5.2 Possible Breakdowns Related to FUNCTIONS.....	20

1. Product Overview

1.1 Display Introduction

Thanks for choosing HUION® KAMVAS® GT-191/GT-220 V2 graphics display. This is a new generation of desktop-level professional drawing display, which can greatly improve your work efficiency of painting and creation, and full of fun. You can freely painting and writing, depicting different lines and colors, just as the pen writes on the paper, which brings you a real shock experience.

To give you a better understanding and using of your KAMVAS, please read this user manual carefully. The user manual only shows the information under Windows, unless otherwise specified, this information applies to both Windows and Macintosh systems.

1.2 Product and Accessories

1.2.1 Display Overview

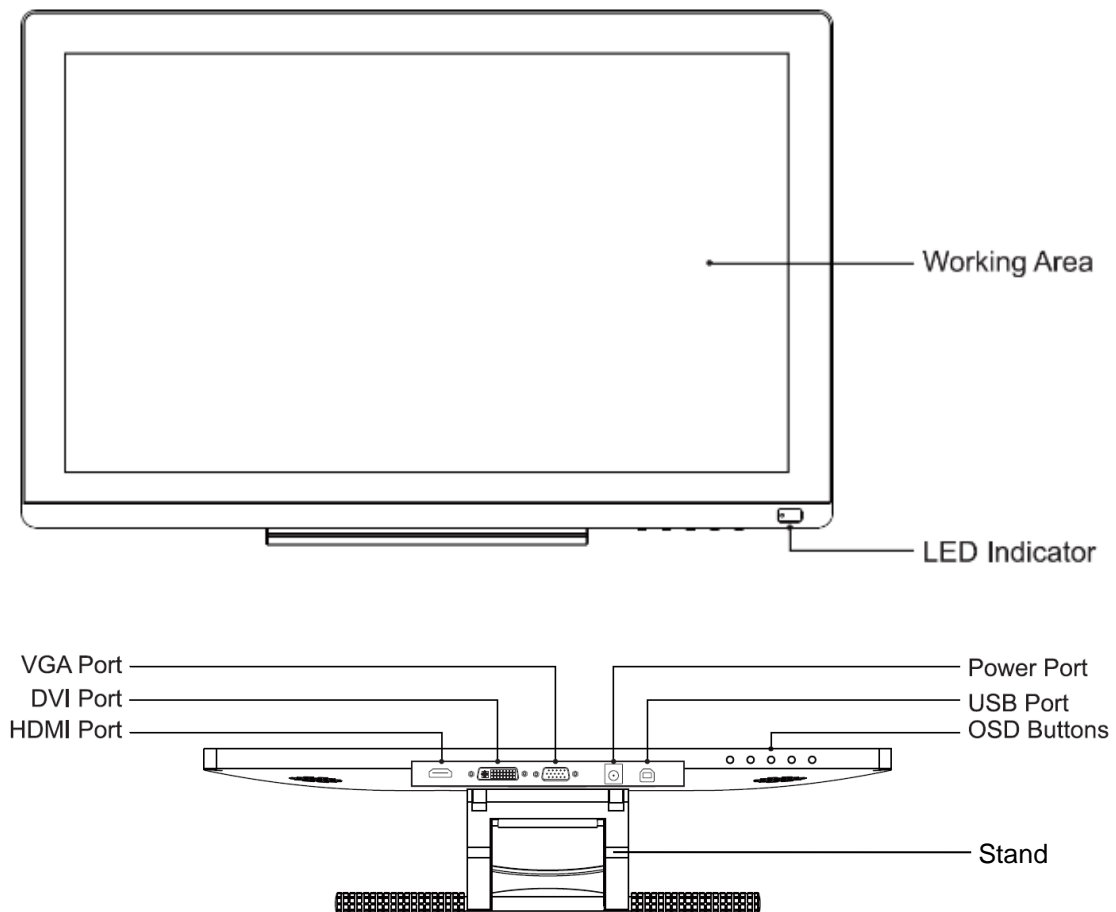

1.2.2 Stylus Pen

The stylus pen is a rechargeable pen with 8192 levels pressure sensitivity and can be used for around 350hrs with full battery.

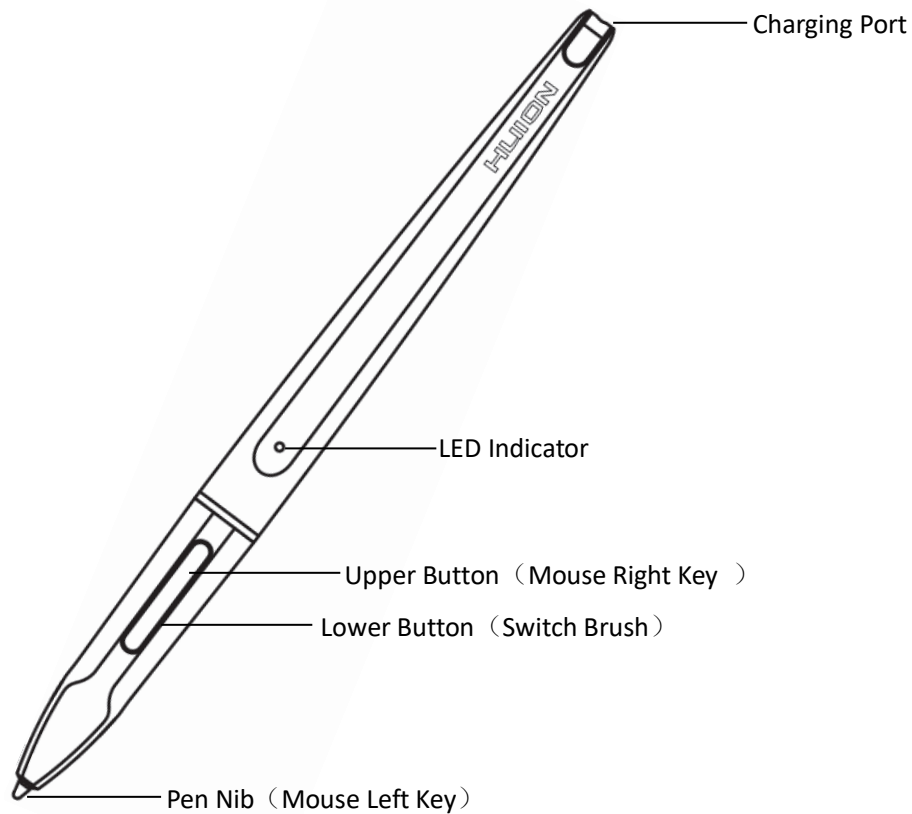

1.2.3 Adjustable Stand

We designed this ergonomic adjustable stand specially for your KAMVAS display, you can adjust the angle of the display according to your usage habit, and make you feel more comfortable when painting and creating.

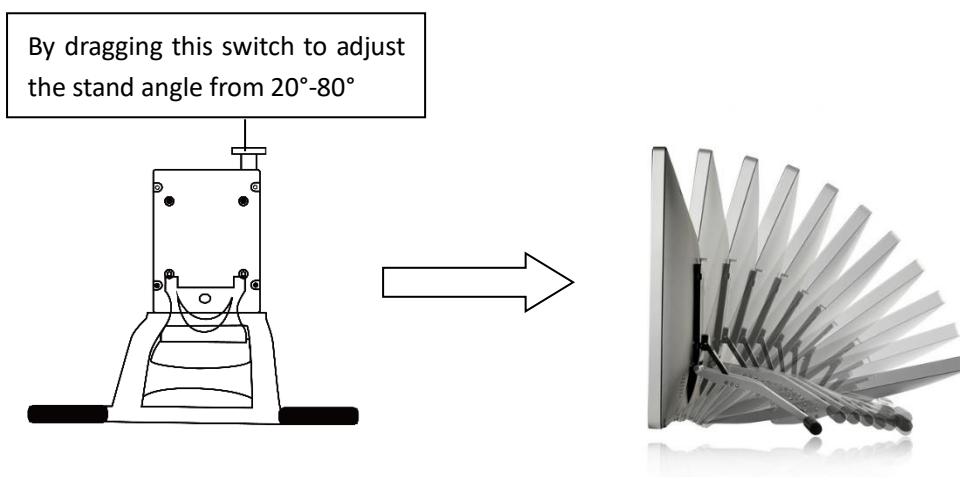

1.2.4 Other Accessories



Pen Box

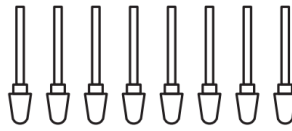

Replacement Nibs

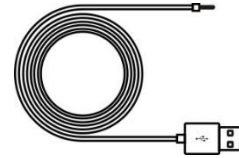

Pen Charging Cable

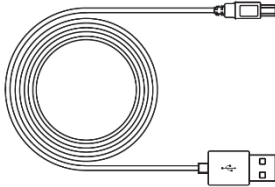

USB Cable

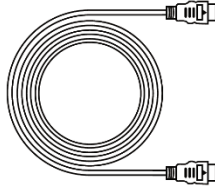

HDMI Cable

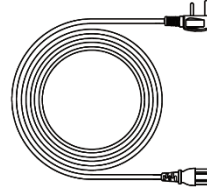

Power Cable

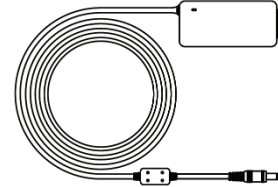

Power Adapter

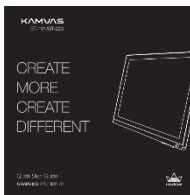

Quick Start Guide



Installation CD

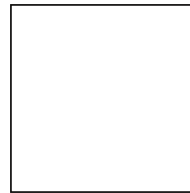

Warranty Card

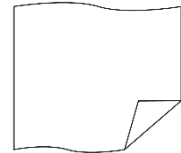

Cleaning Cloth

1.3 Setting up Display

1. Take out the pen display and stand from the package, then assemble the stand to the back of the display with attached screwdriver according to the following instruction.

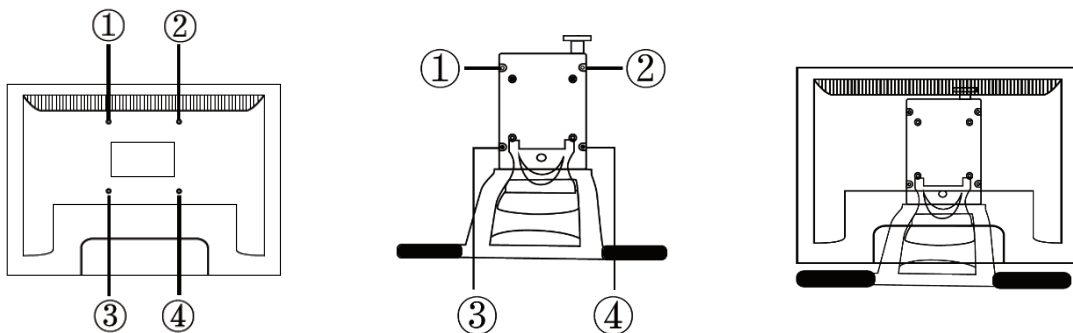

2. As shown on the below, connect the pen display to your computer with attached power adapter, HDMI cable and USB Cable.
3. Press the power button on the bottom of the display to power on the display

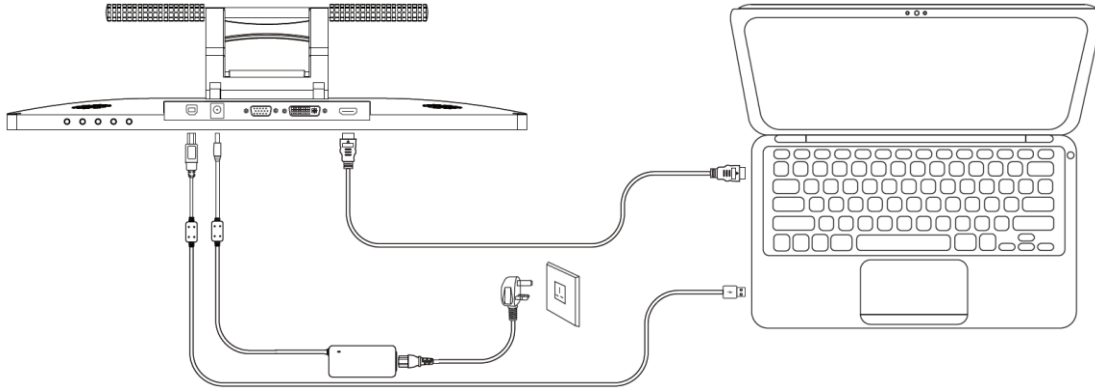

1.4 Installing the Driver

1.4.1 OS Support



Windows 7 or later , macOS 10.11 or later

1.4.2 Install via CD

Insert the CD into the CD drive, the driver will automatically run. If there is no automatic operation, please double click the driver program to run.

1.4.3 Install via Download

You can also download the driver from our website (www.huion.com/download) if there is no CD drive with your computer.

After finishing installation, you can find the driver icon  in the system tray area, which means the driver was installed successfully; when you connect the display to computer, the icon will change to color  which means the driver has already recognized the display and you can start using it now.

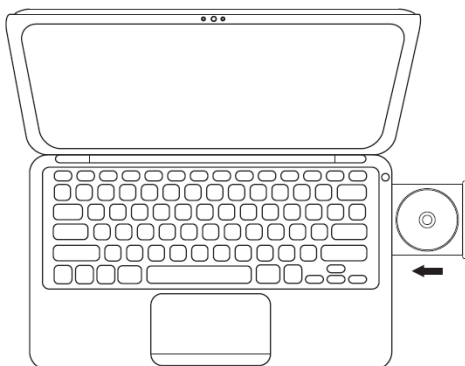

Installing via CD

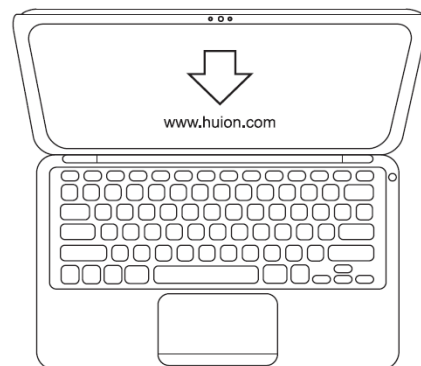

Installing via download

Notice :

1. Before installing, you need to uninstall other driver of similar products, including the old driver of this product;
2. Before installing, please close all graphics software and anti-virus software to avoid unnecessary mistake;

1.5 Pen Nib Replacement

The nib will wear out after using for a long time, then you need to replace a new nib.

1. Anticlockwise rotate the pen holder to open the bottom cover, then you can see the built-in nib clip.
2. Insert the pen nib into the hole and tilt the pen to pull out the old nib.
3. Insert the new nib straight into the pen and push the nib slowly and firmly until it stops.

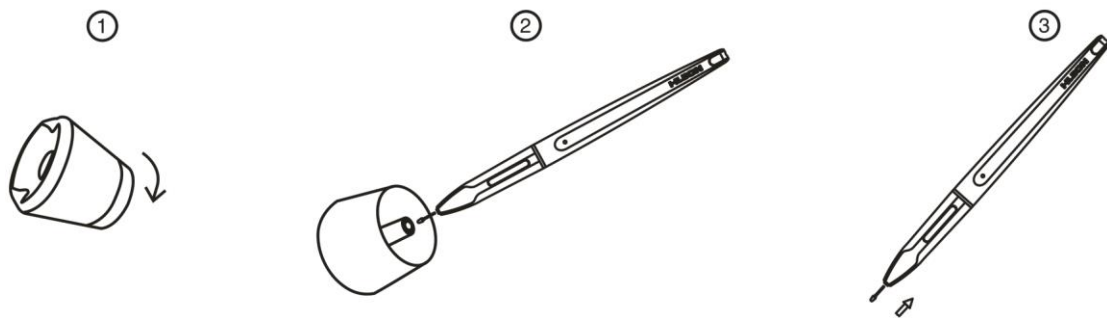

1.6 Charging the Pen

1. When the indicator on the pen shows orange, it means the voltage of the pen is low, then you need to charge the pen.
2. Charge the pen with the attached charging cable. Insert one end of the charging cable into the rear of the stylus charging port, the other end can be connected to a computer, power supply or power bank.

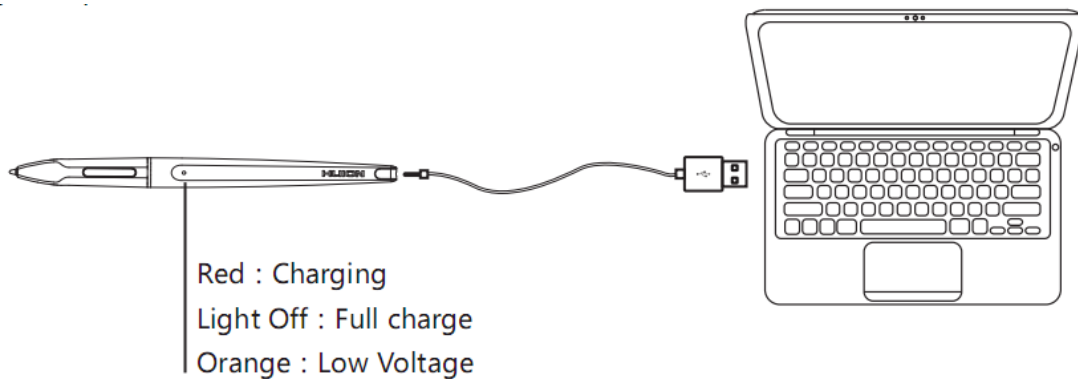

2. Product Basic Operation

2.1 Using The Pen

2.1.1 Hold the pen

Hold the pen as you hold a normal pen or pencil. Adjust your grip so that you can toggle the side switch easily with your thumb or forefinger. Be careful not to accidentally press the switch while drawing or positioning with the pen.

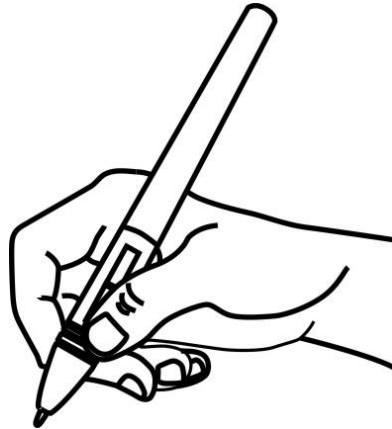

Notice: When not in use, place the pen in the pen case or on the desk. Do not place the pen on the surface of screen, which may interfere with the use of other screen cursor positioning equipment, it may also cause your computer unable to enter the sleep mode.

2.1.2 Position the cursor

Move the pen slightly above the active area without touching the screen surface, the cursor will move to the new position accordingly.

Press the pen tip on the screen to make a selection. Tap the screen once with the pen tip, or touch it to the screen with enough pressure to register a click.

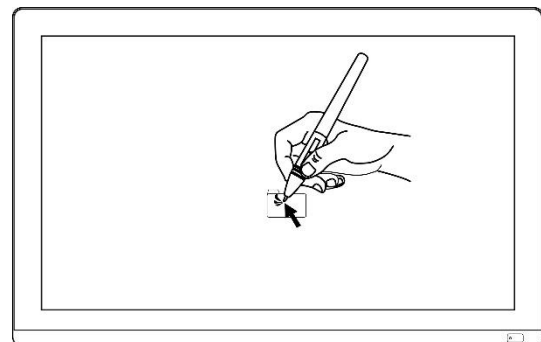
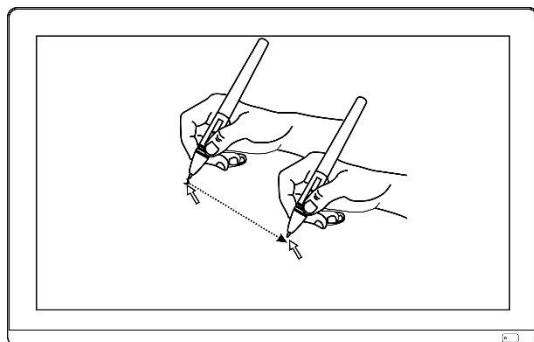

2.1.3 Click

Use the pen tip to tap on the screen once to produce a click. Tap to highlight or select an item on the screen and double-click to open it.

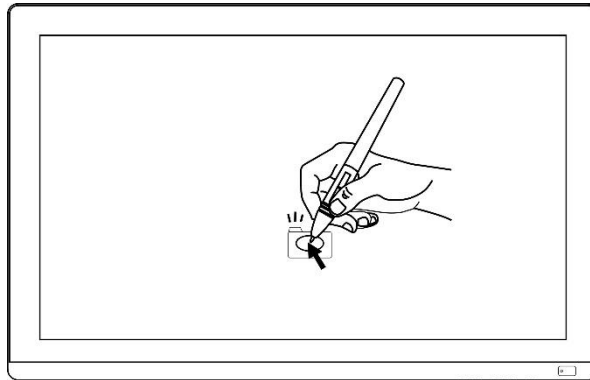

2.1.4 Move

Select the object, then slide the pen tip across the screen to move it.

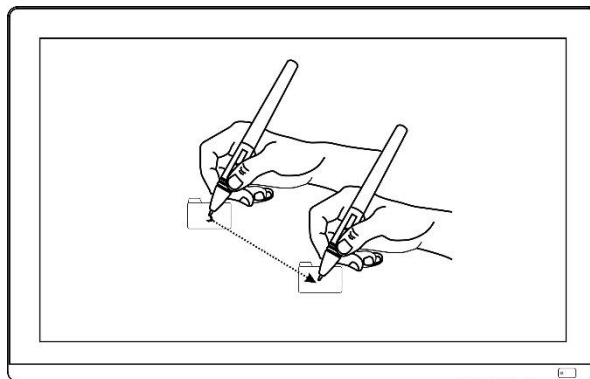

2.1.5 Use the side buttons

The side buttons of the pen can be set to two different customizable functions. You can use the buttons whenever the pen tip is within 10mm of the display active area.

You do not have to touch the pen tip to the display in order to use the switch.

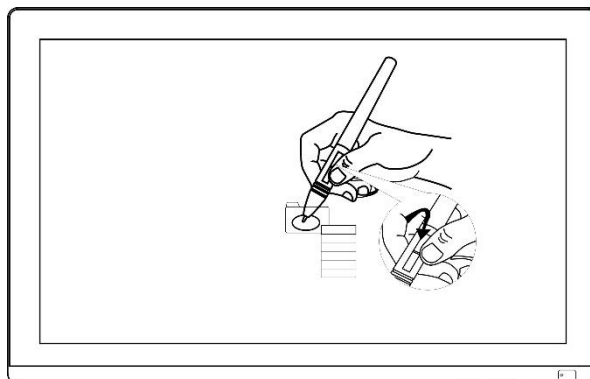

2.2 OSD Setting

2.2.1 OSD Buttons



POWER --- Power on/off the display.

MENU ---- Press to call up the menu, after entering menu, it' s function is confirm.

+ ----- After entering menu, it' s function is to up/right/increase.

- ----- After entering menu, it' s function is to down/left/decrease.

AUTO ----- Before entering menu, it' s function is auto adjustment. After entering menu, it' s function is back to previous menu.

2.2.2 Brightness Setting



1. BRIGHTNESS: Adjusting background brightness of the screen images.press the buttons "+" and "-" to increase and decrease brightness.
2. CONTRAST: Adjusting difference between darkness and brightness of the screen. Press the buttons "+" and "-" to increase and decrease contrast.
3. ECO: There are four eco modes of "STANDARD, TEXT, GAME, MOIVE" .
4. DCR: Choosing "on/off" to on/off Dynamic Contrast Ratio.

2.2.3 Image Setting

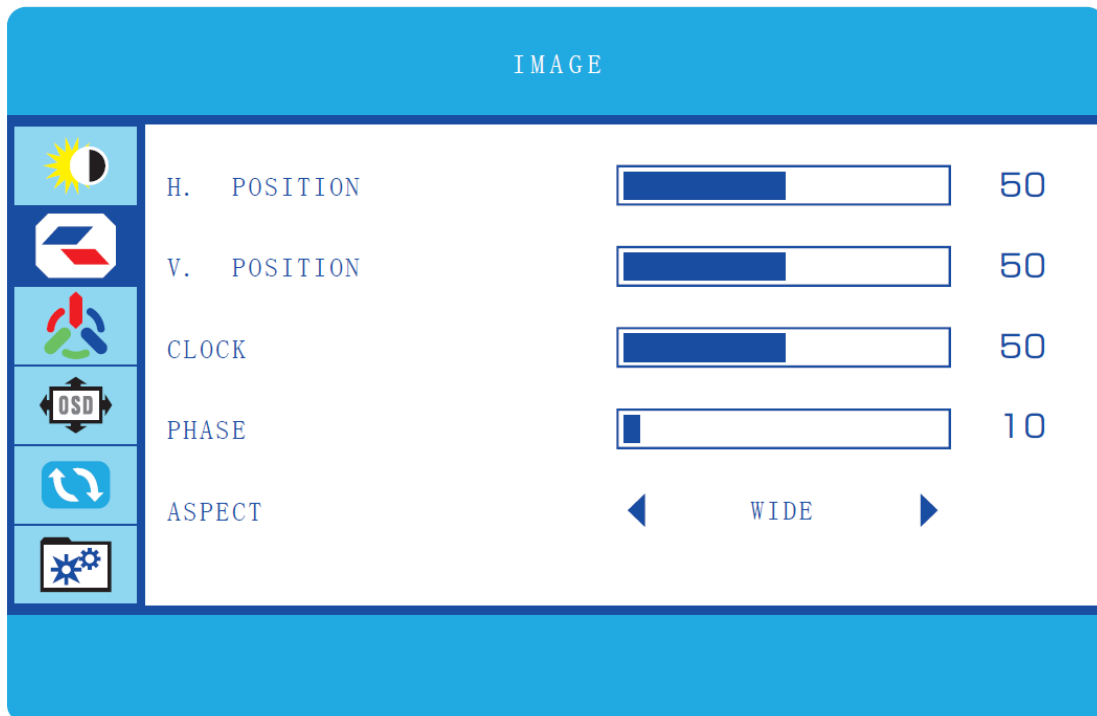

1. H.POSITION: Adjusting images left and right by using the buttons "+" and "-" .
2. V.POSITION: Adjusting images downward and upward by using the buttons "+" and "-" .
3. CLOCK: Adjusting the vertical blinking of characters on the screen.
4. PHASE: Adjusting the horizontal blinking of characters on the screen.
5. ASPECT: There are "WIDE" and "4:3" two modes for you to adjust the aspect of the screen.

2.2.4 Color Temp. Setting

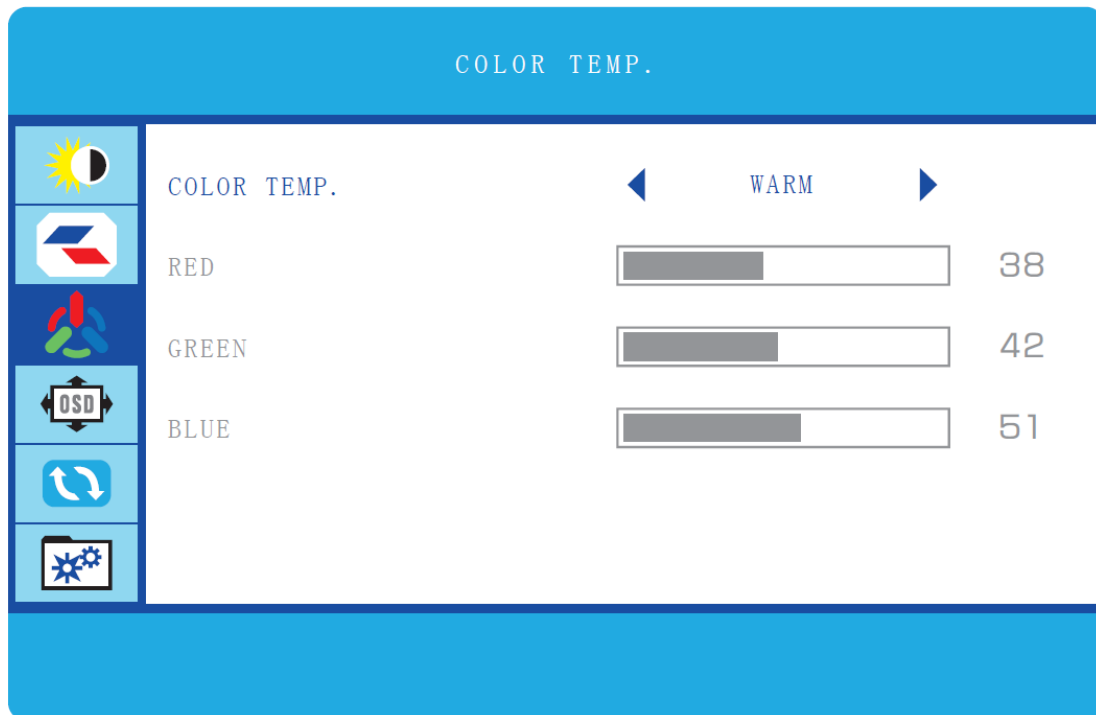

COLOR TEMP.: There are three color modes of "WARM, COOL, USER".

2.2.5 OSD Setting



1. LANGUAGE: There are 12 languages for your choice.
2. OSD H. POS.: Adjusting the OSD position left and right by using the buttons "+" and "-".
3. OSD V. POS.: Adjusting the OSD position downward and upward by using the buttons "+" and "-".
4. OSD TIMER: Increase and decrease the residence time of the OSD menu by using the buttons "+" and "-".
5. TRANSPARENCY: Press "MENU", then "+" and "-" to adjust the transparency of the OSD menu.

2.2.6 Reset

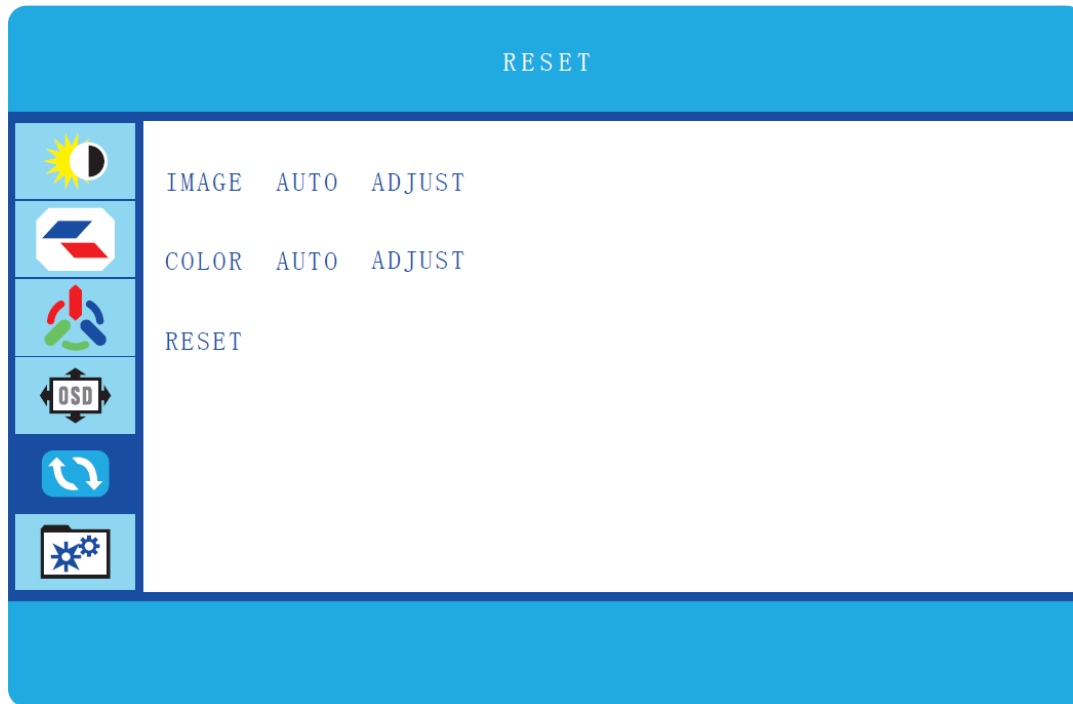

1. IMAGE AUTO ADJUST: Automatically adjust the image' s horizontal/vertical position, focus and clock.
2. COLOR AUTO ADJUST: Automatically adjust the image color balance.
3. RESET: All the setting options will be restored to the default setting.

2.2.7 MISC

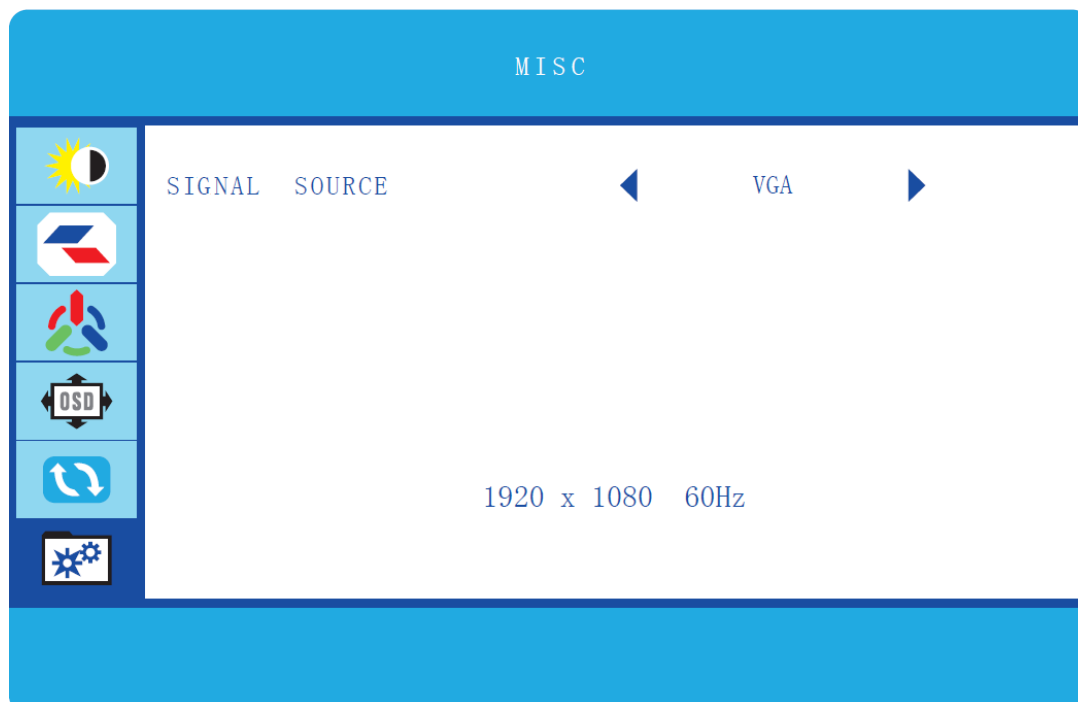

MISC: Display the current adjustment information.

3. Function Setting

3.1 Device Connection Prompt

1. Device disconnected: The computer does not recognize the tablet.
2. Device connected: The computer has recognized the tablet.



3.2 Working Area Setting

3.2.1 Using Multiple Monitors

When the KAMVAS and other monitors are used in the same system, the movement of the screen cursor on the standard display depends on the system configuration. If the secondary display is a mirrored mode connection, KAMVAS and another monitor will display exactly the same image and screen cursor movement. If you are in the extended display mode, you need to set the display on the driver that which portion of the display screen your KAMVAS will map to.

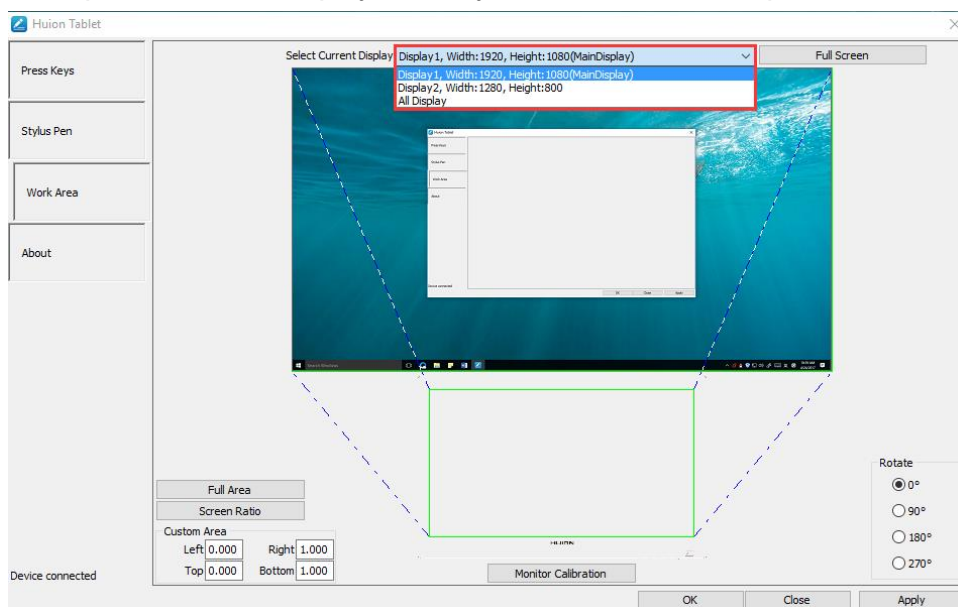

3.2.2 Working Area Setting

Define the display area that will be mapped to the screen area.

1. Full Area: the entire active area of the Display. This is the default setting.
2. Same Ratio with LCD.
3. Customized Area: 1.> Enter coordinate values. or2>. Drag the corners of the foreground graphic to select the screen area.

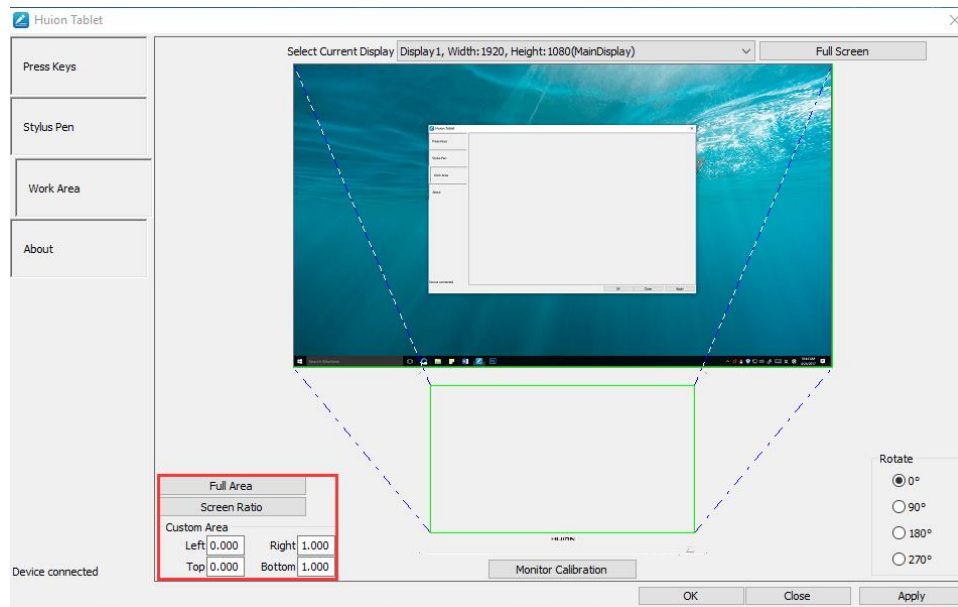

3.2.3 Rotate Working Area

By changing the direction of the tablet to adapt to the left and right hand operation. You can rotate the tablet by 0°, 90°, 180° or 270°.

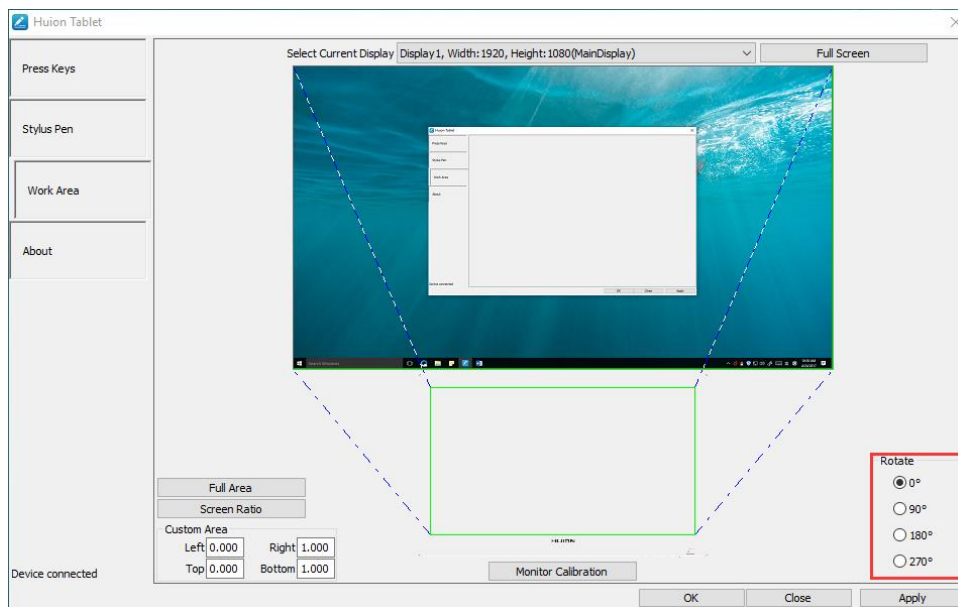

3.3 Pen Button Function Setting

Select the function to be achieved on the pop-up dialog box, then click APPLY or OK to take effect.

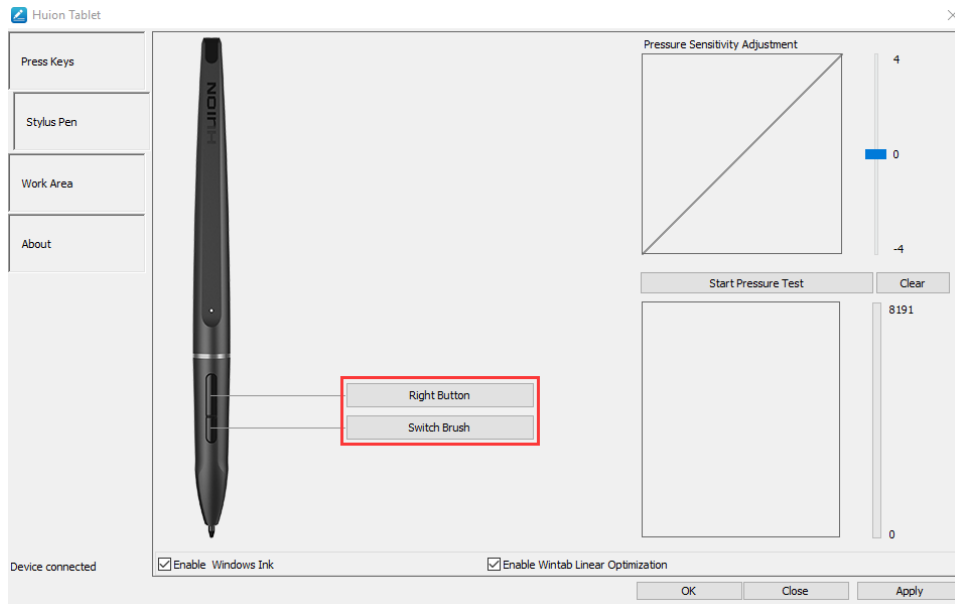

3.4 Pressure Sensitivity Setting

The pressure sensitivity will be changed by dragging the slider up and down, the smaller the value, the more sensitive the pressure.

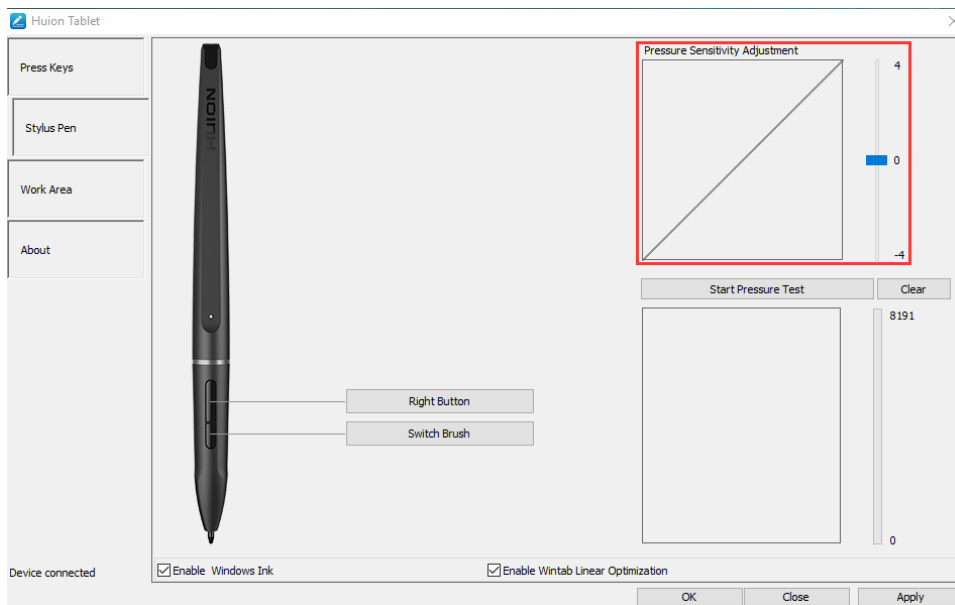

3.5 Pen Pressure Testing

Click "start pressure test" , you can gradually apply pressure to the stylus on the screen to test the pressure level. Click "Clear" button to clear all the ink.

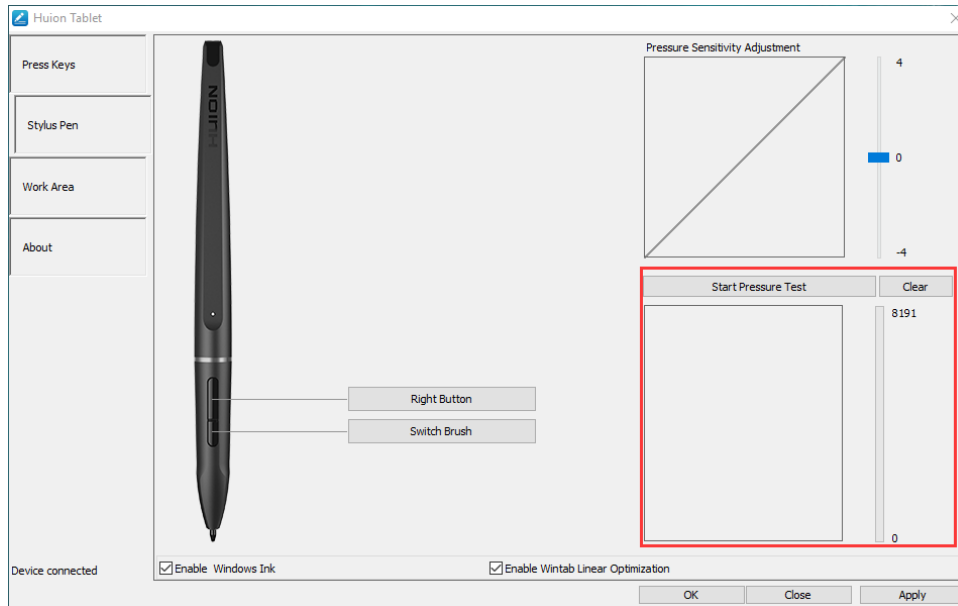

3.6 Calibration

Screen Calibration: Click the red point of the cross center appearing on the screen to complete the calibration.

Restore Factory Settings: Click "Restore Default" to restore to the factory settings.

Cancel Calibration: Click "Cancel calibration" or press ESC on the keyboard to cancel the calibration.

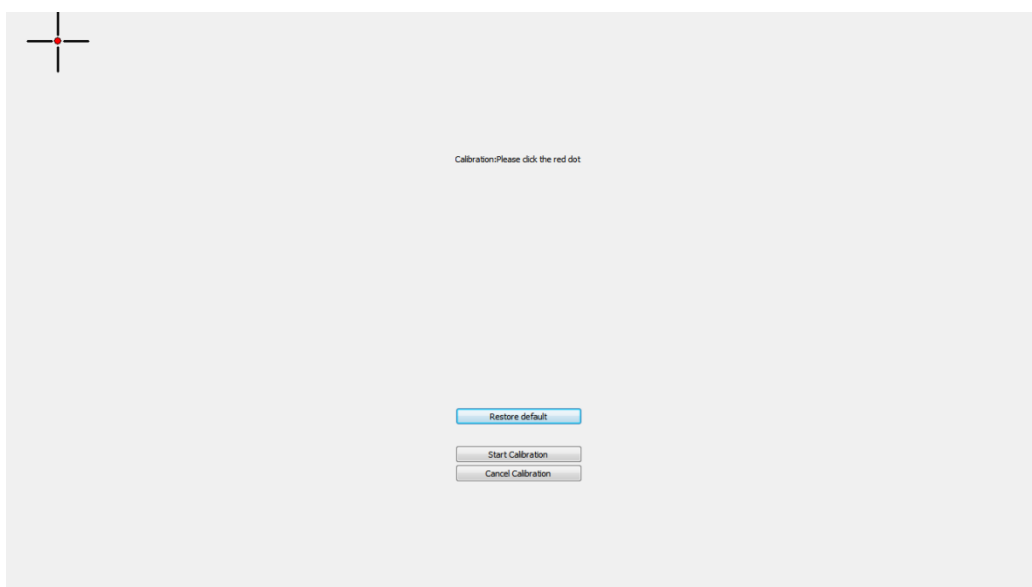

3.7 Enable the Windows Ink feature

Microsoft Windows provides extensive support for pen input. Pen features are supported in such as Microsoft Office、Windows Journal、Adobe Photoshop CC、SketchBook 6 and so on.

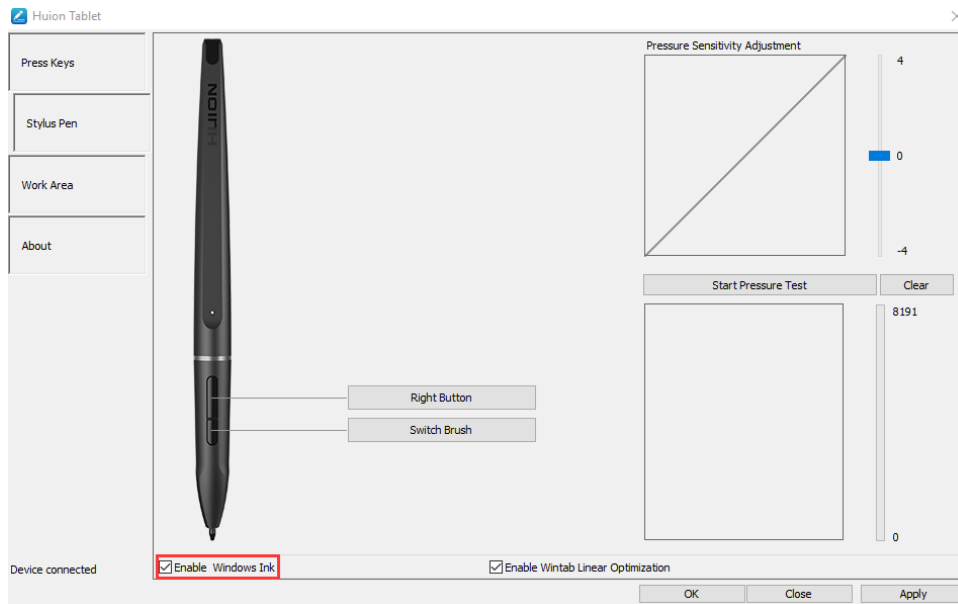

3.8 Data Export and Import

The driver supports exporting and importing your customized configuration data of the product, which is convenient for you to use different software and avoid the trouble of repeated settings.

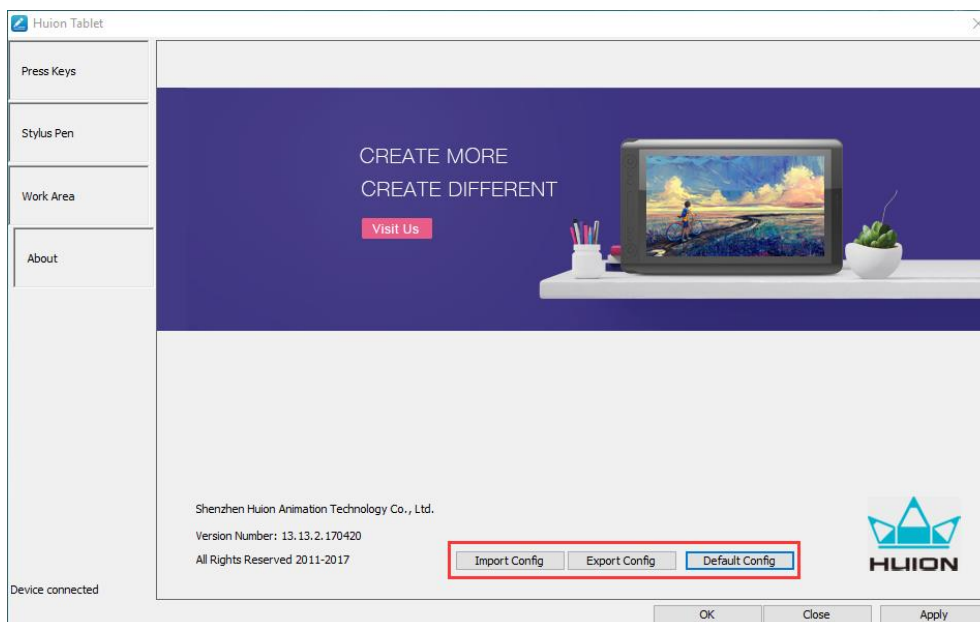

4. Specifications

ITEM		GT-191	GT-220 V2
Screen	Panel Size	19.5 inch	21.5 inch
	Resolution	1920 x 1080(16:9)	1920 x 1080(16:9)
	LCD Type	TFT LCD IPS	TFT LCD IPS
	Active Area	434.88 x 238.68mm	476.64 x 268.11mm
	Contrast Ratio	3000:1	1000:1
	Brightness	250cd/m ²	250cd/m ²
	Response Time	25ms	14ms
	View Angle	89°/89°(H)/89°/89°(V) (Typ.)(CR > 10)	89°/89°(H)/89°/89°(V) (Typ.)(CR > 10)
	Gamut	72%(NTSC)	72%(NTSC)
	Display Color	16.7M	16.7M
Touch	Touch Type	Electromagnetic Resonance	Electromagnetic Resonance
	Resolution	5080LPI	5080LPI
	Pressure Level	8192	8192
	Accuracy	±0.5mm (Center) ±3mm (Corner)	±0.5mm (Center) ±3mm (Corner)
	Sensing Height	12mm	12mm
	Report Rate	233PPS	233PPS
Pen	Model	PE330	PE330
	Type	Cordless Active	Cordless Active
	Net Weight	16.5g	16.5g
	Dimension	Φ13.5x 177.5mm	Φ13.5x 177.5mm
	Buttons	Two Customized Press Key	Two Customized Press Key
	Battery Capacity	80mAh	80mAh
	Charge Time	1.3hrs	1.3hrs
	Life Time	350hrs	350hrs
Auto Sleep	15mins	15mins	
General	Working Power Consumption	36W	36W
	Input Voltage	100-240VAC, 50/60Hz	100-240VAC, 50/60Hz
	Output Voltage	DC12V 3A	DC12V 3A
	Video Interface	HDMI、DVI、VGA	HDMI、DVI、VGA
	Dimension	475 x 298 x 35mm (Without Stand)	520 x 325 x 37mm (Without Stand)
	Net Weight	3.3KG(without stand)	3.7KG(without stand)
	Adjustable Stand	20°-80°	20°-80°
	OS Support	Windows 7 or later, macOS 10.11 or later	Windows 7 or later, macOS 10.11 or later

5. Trouble Shooting

5.1 Possible Breakdowns Related to DISPLAY

Abnormal Phenomena	Possible Solutions
Power indicator does not flash	*Make sure power is on *Check the socket and power cable
No display on the screen	<ol style="list-style-type: none"> 1. Make sure power is on. 2. Correctly connect the cable. 3. If you connect the display with a laptop, please make sure the display is on the right display mode: extend or duplicate mode. 4. Check whether the side indicator shows green, if not, it means no signal in. Please reboot your computer or reconnect the cable. 5. Is the signal wire broken or bent? If so, please replace the signal wire.
Images are blurred	Please set the display resolution with 1920 x 1080.
Lack of colors	Check the pins of the signal wire are not bent or fractured.
There is chromatic aberration	As the regional color temperature is different, so minor chromatic aberration is a normal phenomenon.
Images jitter or ripple images appear	It is likely that there is electric equipment nearby that brings about electronic interference.

5.2 Possible Breakdowns Related to FUNCTIONS

Abnormal Phenomena	Possible Solutions
Pen doesn't work and no pressure in the graphics software	<ol style="list-style-type: none"> 1. If the driver is damaged or is not properly installed, please uninstall the driver and reinstall it. 2. Whether the power of the pen is exhausted, if so, Please recharge. 3. Try restarting your computer. 4. Try re-inserting the USB cable.
Cursor movement is abnormal	Try re-inserting the USB cable or restarting your computer.
The side button of the pen doesn't work	When pressing the side button, please make sure that the nib didn't touch the glass surface and the distance between the nib and surface is within 10mm
There is a deviation between the tip and the cursor	Try calibration

Note: Information in this manual is subject to change without further notice.

For more information, please contact us with our email: service@huion.com

Or go to our website (www.huion.com) to get the latest driver and user manual.